

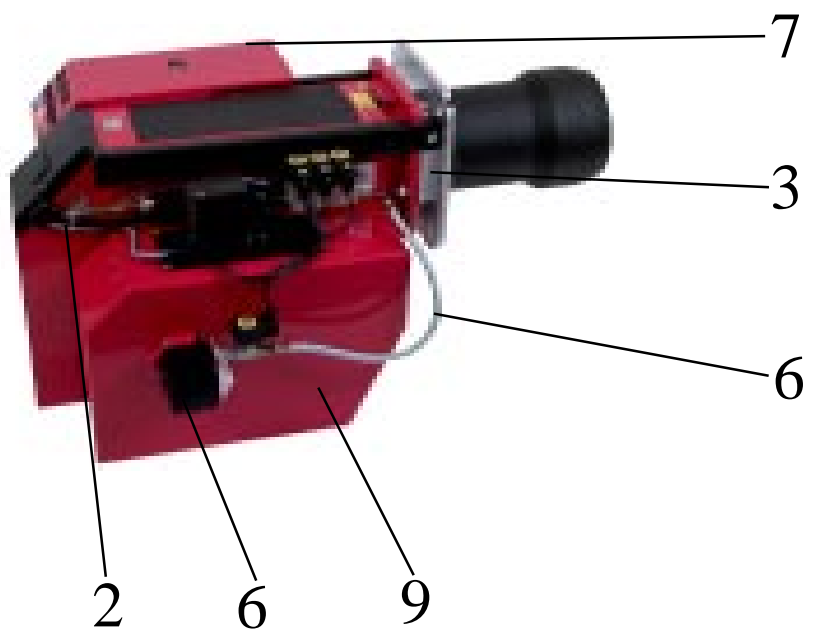

70,80

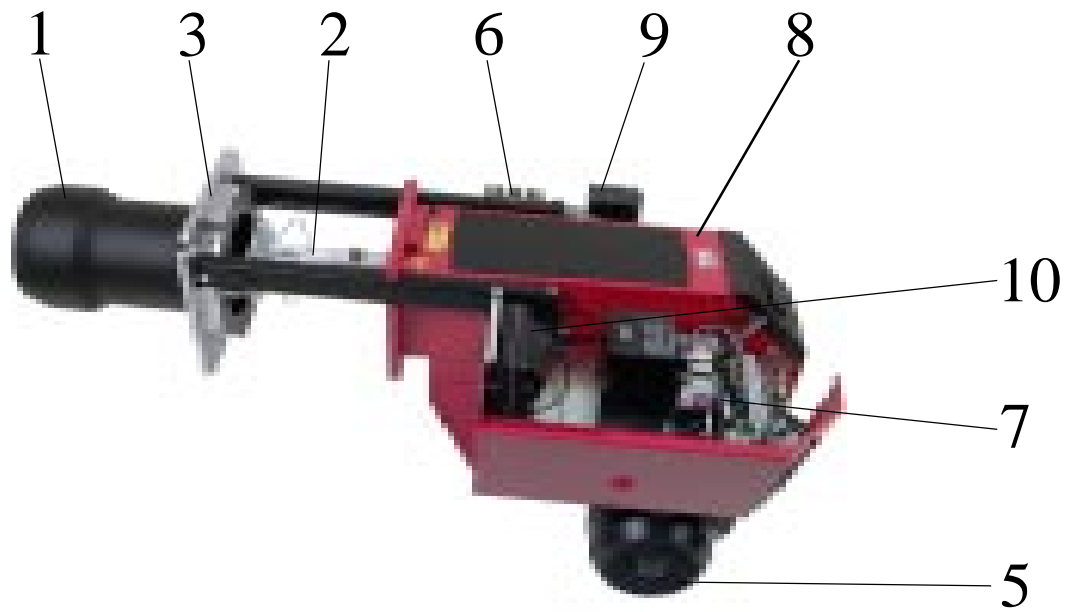

INNEHÅLLSFÖRTECKNING

1. BRÄNNARRÖR	Brännarrör Övrigt	
2. INSATS	Insats Oljerör Bromsskiva	Övrigt
3. ANSLUTNINGSFLÄNS	Anslutningsfläns Packning Övrigt	
4. KÅPA	Kåpa Fäste Övrigt	
5. MOTOR	Motor Kondensator Fläkthjul	Koppling Övrigt
6. PUMP	Pump Magnetventil Filter	Förbindelserör Övrigt
7. ELDNINGSAUTOMAT	Eldningsautomat Fotomotstånd Övrigt	
8. FLÄKTHUS	Fläkthus Övrigt	
9. LUFTREGLERING	Luftreglering Övrigt	
10. TRANSFORMATOR	Transformator Övrigt	
11. SLANG	Slang Övrigt	

TABLE OF CONTENTS

1. BURNER TUBE	Burner tube Other articles	
2. NOZZLE ASSEMBLY	Nozzle assembly Nozzle line Shrouded disc	Other articles
3. FIXING FLANGE	Fixing flange Gasket Other articles	
4. COVER	Cover Attachment Other articles	
5. MOTOR	Motor Capacitor Fan wheel	Coupling Other articles
6. PUMP	Pump Solenoid valve Filter	Connecting pipe Other articles
7. OIL BURNER CONTROL	Oil burner control Photoresistor Other articles	
8. FAN HOUSING	Fan housing Other articles	
9. AIR REGULATION	Air regulation Other articles	
10. TRANSFORMER	Transformer Other articles	
11. FLEXIBLE PIPE	Flexible pipe Other articles	

INHALTSVERZEICHNIS

1. BRENNERROHR	Brennerrohr Sonstiges	
2. DÜSENSTOCK	Düsenstock Düsenrohr Stauscheibe	Sonstiges
3. BEFESTIGUNGS- FLANSCH	Anschlussflansch Dichtung Sonstiges	
4. ABDECKHAUBE	Abdeckhaube Befestigung Sonstiges	
5. MOTOR	Motor Kondensator Gebläserad	Kupplung Sonstiges
6. PUMPE	Pumpe Magnetventil Filter	Öldruckrohr Sonstiges
7. FEUERUNGSAUTOMAT	Feuerungsautomat Fotowiderstand Sonstiges	
8. BRENNERGEHÄUSE	Brennergehäuse Sonstiges	
9. LUFTEINSTELLUNG	LuftEinstellung Sonstiges	
10. TRANSFORMATOR	Transformator Sonstiges	
11. NIPPEL	Ölschlauch Sonstiges	

TABLE DES MATIERES

1. TUBE DIFFUSEUR	Tube diffuseur D'autres articles	
2. LIGNE PORTE- GICLEUR	Ligne porte-gicleur Canne porte-gicleur Disque accroche-flamme	D'autres articles
3. BRIDE DE FIXATION	Bride de fixation Joint D'autres articles	
4. CAPOT	Capot Fixation D'autres articles	
5. MOTEUR	Moteur Condensateur Rotor	Manchon D'autres articles
6. POMPE	Pompe Electrovanne Filtre	Trompette D'autres articles
7. COFFRET DE SECURITE	Coffret de sécurité Cellule photorésistante D'autres articles	
8. CARTER DU ROTOR	Carter du rotor D'autres articles	
9. REGLAGE D'AIR	Réglage d'air D'autres articles	
10. TRANSFORMATEUR	Transformateur D'autres articles	
11. FLEXIBLE	Flexible D'autres articles	

70, 80

BRÄNNARRÖR BRENNERROHR

BURNER TUBE TUBE DIFFUSEUR

1



Brännarrör
363 mm
663 mm
70

Burner tube
363 mm
663 mm
70

Brennerrohr
363 mm
663 mm
70

Tube diffuseur
363 mm
663 mm
70

119 194 0105

119 194 0205



Brännarrör
396 mm
696 mm
80

Burner tube
396 mm
696 mm
80

Brennerrohr
396 mm
696 mm
80

Tube diffuseur
396 mm
696 mm
80

119 266 0105

119 266 0105

70, 80

INSATS DÜSENSTOCK

NOZZLE ASSEMBLY LIGNE PORTE-GICLEUR 2

	Insats	Nozzle assembly	Düsenstock	Ligne porte-gicleur	
	Standard	Standard	Standard	Standard	
	70	70	70	70	119 454 01
	80	80	80	80	119 454 02
	Långt utförande	Long design	Längere Ausf.	Modèle long	
	70	70	70	70	119 454 03
	80	80	80	80	119 454 04
	Oljerör	Nozzle line	Düsenrohr	Canne porte-gicleur	
	Standard	Standard	Standard	Standard	118 968 01
	Långt utförande	Long design	Längere Ausf.	Modèle long	118 968 02
	Bromsskiva	Brake plate	Stauscheibe	Disque accroche-flamme	
	70	70	70	70	112 841 42
	80	80	80	80	119 325 01
	Tändeledrod-par	Pair of ignition electrode	Zündelektrode-paar	Electrode d'allumage 1 paire	919 247 01
	Klammer	Bracket	Klammer	Support	112 738 01
	Axel kpl	Axle compl.	Welle kompl.	Arbre compl.	119 471 01
	Ställplatta kpl	Adjustment plate compl.	Stellplatte kompl.	Platine de réglage compl.	119 468 01
	Reglerdon	Adjustment device	Regelgerät	Dispositif de réglage	919 263 01
	Packning	Gasket	Dichtung	Joint	111 844 01
	Klammer	Bracket	Klammer	Support	111 552 01



Anslutningsfläns
kompl.
Anslutningsfläns
Gejder

Fixing flange
compl.
Fixing flange
Guide bars

Anschlussflansch
kompl.
Anschlussflansch
Führungsstängen

Bride de fixation
compl.
Bride de fixation
Barres de
guidage

119 455 01

119 153 01

119 142 01



Packning
fläkthus-fläns

Gasket
fan housing-
flange

Dichtung,
Brennergehäuse-
Flansch

Joint, carter du
rotor-bride

119 152 01









Packning

Gasket

Dichtung

Joint

112 788 07

	Motor 70 3.0 kW 80 5.5 kW Kabel	Motor 70 3.0 kW 80 5.5 kW Cable	Motor 70 3.0 kW 80 5.5 kW Kabel	Moteur 70 3.0 kW 80 5.5 kW Câble	117 911 03 117 911 04 119 449 03
	Fläkthjul 70 80	Fan wheel 70 80	Gebläserad 70 80	Rotor 70 80	112 776 07 112 776 22
	Motorfläns	Flange, motor	Motorflansch	Bride, moteur	119 043 0105
	Drivkoppling	Drive coupling	Antriebskupplung	Accouplement d'entraînement	113 094 06
	Avskärningskon 70	Conical shield plate 70	Abschirmkonus 70	Cône deflecteur d'air 70	119 144 01
	Avskärningskon 80	Conical shield plate 80	Abschirmkonus 80	Cône deflecteur d'air 80	119 062 01

	Pump RSA125	Pump RSA125	Pumpe RSA125	Pompe RSA125	110 197 19
	Magnetventil kpl	Solenoid valve compl	Magnetventil kompl	Electrovanne compl.	119 469 01
	Magnetventil Nippel	Solenoid valve Nipple	Magnetventil Nippel	Electrovanne Raccord	119 025 01
	Spole VE140	Coil VE140	Spule VE140	Bobine VE140	056 205 02 115 879 02
	Magnetventilblock kpl	Solenoid valve bloc compl	Magnetventilblock kompl	Jeu d'electrovanne compl	119 453 01
	Magnetventilblock	Solenoid valve bloc	Magnetventilblock	Jeu d'electrovanne	119 161 01
	Magnetventil Spole	Solenoid valve Coil	Magnetventil Spule	Electrovanne Bobine	914 967 02 114 965 01
	Hydraulslang, magnetventilblock- reglerdon	Hydraulic hose, solenoid valve bloc-adjustment device	Hydraulischer Ölschlauch, Magnetventilblock- Regelgerät	Tuyau hydraulique, jeu d'electrovanne- dispositif de réglage	118 293 02
	Hydraulslang, magnetventilblock- pump	Hydraulic hose, solenoid valve bloc-pump	Hydraulischer Ölschlauch, Magnetventilblock- Pumpe	Tuyau hydraulique, jeu d'electrovanne- pompe	119 168 01
	O-ring R2025	O-ring R2025	O-Ring R2025	Joint torique R2025	113 168 05
	O-ring 4.48x1.78	O-ring 4.48x1.78	O-Ring 4.48x1.78	Joint torique 4.48x1.78	113 168 02
	Filtersats RSA	Filter set RSA	Filtersatz RSA	Jeu de filtre RSA	117 833 01
	Winkel	Angle	Winkelnippel	Coude	118 404 01









	Reläbox LAL 1.25 Industriförpackning	Control box LAL 1.25 Industrial package	Steuergerät, Oberteil LAL 1.25 Industrie verpackung	Boite de contrôle LAL 1.25 Emballage industriell	114 939 01
	Styckförpackning	Single-piece package	Stückverpackung	Emballage par pièces	914 939 01
	Reläsocket LAL	Relay base LAL	Steuergerät, Unterteil LAL	Socle de raccordement, boite de contrôle LAL	114 942 00
	Fotomotstånd QRB1-A kpl.	Photoresistor QRB1-A compl.	Fotowiderstand QRB1-A compl.	Cellule photorésistante QRB1-A compl.	
	700 mm 1500 mm	700 mm 1500 mm	700 mm 1500 mm	700 mm 1500 mm	912 409 08 912 409 81
	Fläns, fotomotstånd	Flange, Photoresistor	Flansch, Fotowiderstand	Bride, cellule photorésistante	112 405 01
	Kontaktor 70	Contacteur 70	Kontaktor 70	Contacteur 70	113 110 01
	Strömbrytare	Switch	Schalter	Interrupteur	117 212 01
	Indikeringslampa grön	Indicating lamp green	Anzeigelampe grün	Lampe témoin verte	117 211 03
	Timräknare	Time meter	Betriebsstunden- zähler	Compteur horaire	117 678 01
	Säkringshållare	Fuse holder	Sicherungshalter	Support de fusée	118 118 03

70, 80

ELDNINGSAUTOMAT FEUERUNGSAUTOMAT

OIL BURNER CONTROL COFFRET DE SECURITE 7

	Kontaktor 80	Contacteur 80	Kontaktor 80	Contacteur 80	113 110 02
	Överströmsskydd	Thermal overload protection	Überstromschutz	Déclencheur à maxima d'intensité	
	6-9,2 A 70	6-9,2 A 70	6-9,2 A 70	6-9,2 A 70	113 111 05
	8-12 A 80	8-12 A 80	8-12 A 80	8-12 A 80	113 111 08
	Säkring 6,3 A	Fuse 6,3 A	Sicherung 6,3 A	Fusible 6,3 A	113 332 01
	Kontaktbon 7+4+5+4 pol	Plug-in contact 7+4+5+4-pole	Stecker und Buchsenteil 7+4+5+4-polig	Fiche de Prise de courant 7+4+5+4-polaire	
	70	70	70	70	119 486 10
	80	80	80	80	119 486 08
	7 pol, hane	male, 7-pole	Steckerteil 7-polig	mâle, 7-polaire	115 585 00
	7 pol, hona	female, 7-pole	Buchsenteil 7-polig	femelle, 7-polaire	119 098 04
	4-pol, hane svart	male, 4-pole black	Steckerteil 4-polig Schwarz	mâle, 4-polaire noir	119 103 01
	grön	green	Grün	verte	119 197 01
	4-pol, hona svart	female, 4-pole black	Buchsenteil 4-polig Schwarz	femelle, 4-polaire noir	119 104 01
	grön	green	Grün	verte	119 198 01
	5-pol, hane	male, 5-pole	Steckerteil 5-polig	mâle, 5-polaire	119 199 01
5-pol, hona	female, 5-pole	Buchsenteil 5-polig	femelle, 5-polaire	119 200 01	

	Lock	Cover	Deckel	Couvercle	119 254 0105
	Skyddsgaller	Protective grating	Schutzgitter	Grille de protection	119 048 01
	Kåpa, inspektionsglas Inspektionslock	Cover, inspection glass Inspection cover	Haube, Schauglas Deckel Schauglas	Capot, viseur de flamme Couvercle, viseur de flamme	119 066 0105 117 080 01
	Hjul kpl.	Bearing compl.	Lager kompl.	Palier compl.	119 462 01
	Packning	Gasket	Dichtung	Joint	117 953 01
	Inspektionsglas	Inspection glass	Schauglas	Viseur de flamme	118 088 01
	Säkringsring	Locking ring	Sicherungsring	Circlip	118 018 01
	Packning	Gasket	Dichtung	Joint	119 151 02

	Spjällmotor kpl. SQN75.436A21B	Servo motor compl. SQN75.436A21B	Stellmotor kompl. SQN75.436A21B	Servo moteur compl. SQN75.436A21B	119 423 01
	Fästplatta, spjällmotor	Covering plate, servo motor	Deckplatte, Stellmotor	Plaque de recouvrement, servo moteur	119 149 01
	Pinnskruv, fästplatta	Stud screw, covering plate	Stiftschraube, Deckplatte	Vis à goupille, plaque de recouvrement	119 203 01
	Luftspjäll kpl.	Air damper compl.	Luftklappe kompl.	Volet d'air compl.	119 463 01
	Länkarm kpl.	Slewing bracket compl.	Gelenkarm kompl.	Pivot compl.	119 470 01
	Mät nipple	Test nipple	Messnippel	Raccord de mesure	118 053 01

70, 80

TRANSFORMATOR
TRANSFORMATOR

TRANSFORMER
TRANSFORMATEUR 10



Transformator
Tändkabel
500 mm
800 mm

Transformer
Ignition cable
500 mm
800 mm

Transformator
Zündkabel
500 mm
800 mm

Transformateur
Câble H.T.
500 mm
800 mm

917 456 03
118 049 06
118 049 09

70, 80

SLANG ÖLSCHLAUCH

FLEXIBLE PIPE FLEXIBLE

11



Oljeslang

Flexible pipe

Ölschlauch

Flexible

113 542 08



Nippel

Nipple

Nippel

Raccord

117 574 01